

- Modular Switch Design
- 10, 20, 30, 40 or 50 SPST Switches per Plug-in
- Cold Switch up to 9 kVDC/9 kVAC Peak
- Hot Switch up to 7.5 kVDC/7.5 kVAC Peak
- 0.25 A Hot Switch Current
- Maximum Power 50 W
- Dry Reed Switch Contacts With RFI Suppression for Long Life
- Hardware Interlock Provided
- Built-In Scan List Sequence Stores With Triggering Capability
- Fully Compliant to 1.5 LXI Standard
- 3 Year Warranty



PRELIMINARY DATA

The 65-233 is a modular switching platform that provides a high voltage SPST solution with capability up to 9 kV.

Switch arrays are created by populating a 65-200 chassis with plug-in modules that provide access to the switches on 51-pin front panel connectors. Users can specify as many or as few plug-in modules as they require and can field upgrade the chassis to extend the number of switches.

A hardware interlock connector is provided on the front panel that prevents relay operation if a suitably wired mating connector is not fitted. This can, for example, be used to disable relay operation if the test system cabinet door is open.

The chassis supports up to 6 plug-in modules which are loaded into the chassis via the front panel, greatly improving flexibility and ease of maintenance.

Cooling for the 65-200 chassis is provided by rear fans and front air intakes ensuring no wasted space when the chassis is rack mounted. The cooling system is adaptive, ensuring the acoustic noise is minimised when used in quiet laboratory environments and low load conditions.

Configuring the Switch

To select the parts that needed to create a switching array simply:

- Specify a 65-200-002 Modular Switching Chassis.
- Add 65-233-9xx-HI SPST High Voltage Plug-in Modules as required.

Switch Path Manager (SPM) Signal Routing Software

The 65-233 comprises multiple separate smaller elements that can be combined to form the overall switch. To aid with the user experience the Pickering [Switch Path Manager](#) application can be used. This simplifies signal routing through switching systems and speeds up the development of switching system software. See page 8 of this datasheet for more information.

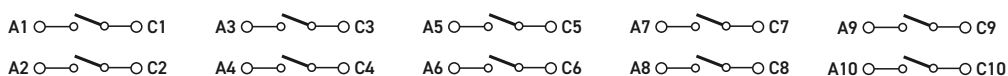

10xSPST High Voltage Switch Plugin Module
(Part No. 65-233-904-HI)

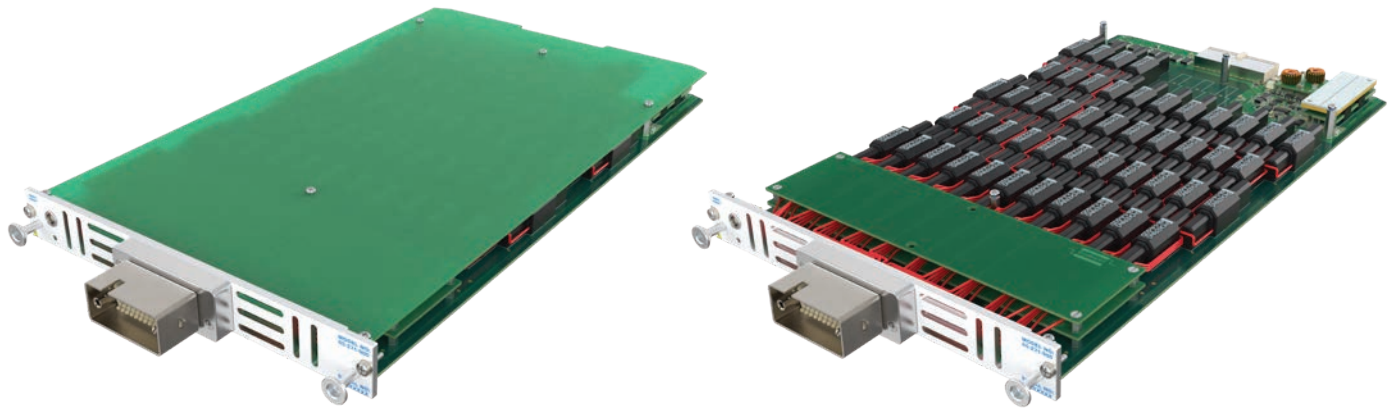

Example of a High Voltage Switching Plugin Module With and Without Protective Cover

RFI Suppression

The 65-233 includes RFI suppression that extends relay contact life in hot switching applications and controls surges caused by high voltage transients in cold switching applications. The suppressors also ensure safe operation when connected to a high voltage source via cable assemblies that might otherwise generate additional transients or RFI problems.

The suppression components result in reduced bandwidth and slightly higher path resistance compared to standard designs (please refer to the switching specification table).

Please note, it is good practice to keep high voltage switching modules away from more sensitive units to minimize crosstalk.

Hardware Interlock

The 65-233 plug-in modules are fitted with a hardware interlock. The interlock, when activated, will return all relays to their default unpowered state (assuming the switches are fully functional) and also provide error notification via the software interface. The interlock feature can be daisy-chained between additional hardware interlock enabled modules for example to allow one signal to disable multiple cards. For further details please refer to the Hardware Interlock section within the user manual.

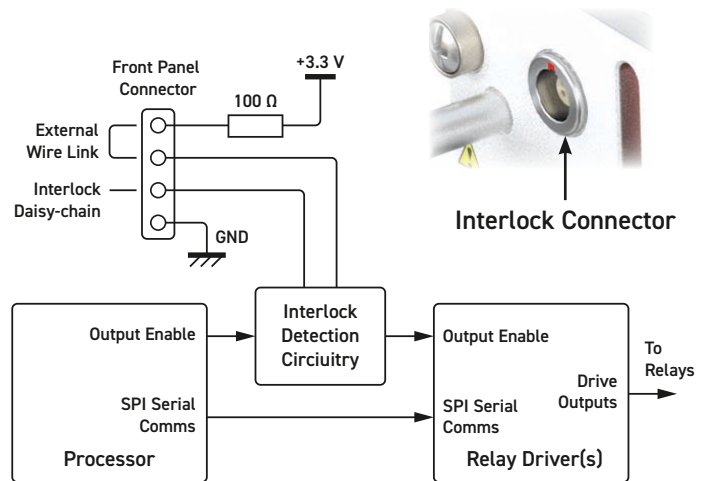

Interlock Signal Routing Diagram for 65-233

PRELIMINARY DATA

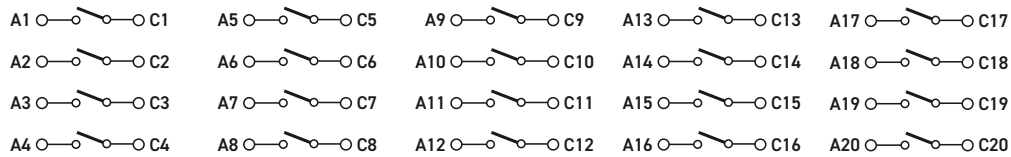

65-233-903-HI 20xSPST

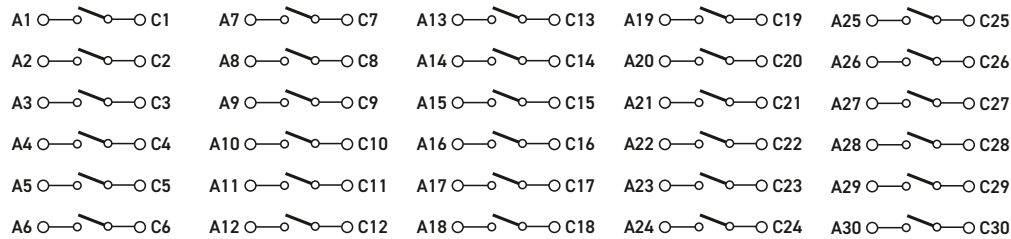

65-233-902-HI 30xSPST

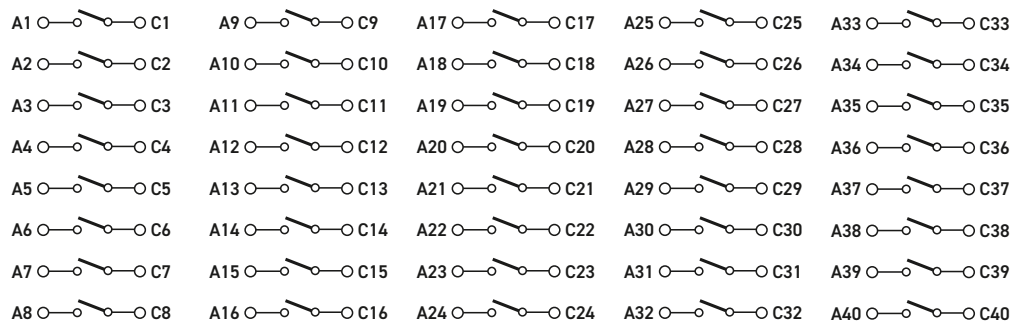

65-233-901-HI 40xSPST

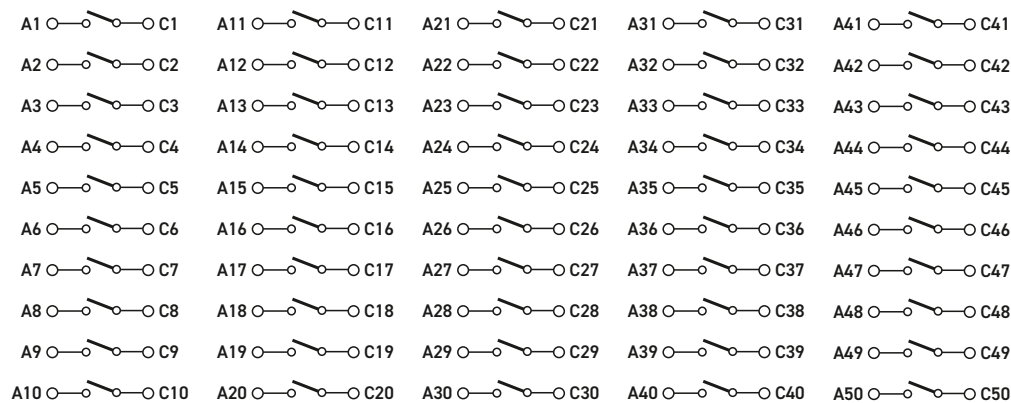

65-233-900-HI 50xSPST

Switching Diagrams For 65-233-90x-HI High Voltage SPST Switch Plugin Module Range

PRELIMINARY DATA

Sequencing Service and Triggering

The Sequencing service provides the user with the ability to set a series of pre-determined sequences on an LXI instrument. These sequences can be triggered by software or one of the sixteen software configurable open collector triggers.

As the operations are grouped together, it will minimize the number of control transactions required to achieve a composite change of target switch state, condensing multiple operations in a single sub unit into a single operation, thus reducing the overall system switch settling time.

For example, if a user wants to operate X1-Y1, X4-Y1, X2-Y2, in the first sequence, only one operation, and so delay, will be used.

Additionally, as the switch state sequences are stored within the LXI controller itself, the burden on the Host CPU and Ethernet traffic is greatly reduced, and so the overall system latency is also reduced.

This unit features a software reset line which provides the ability for a user supplied reset to be applied to the unit, triggering a software reset of the relays, returning all relays

in the unit to their default state. There is also a software fault line available that will be triggered if there is any error detected within the unit. Please note that while these reset and fault lines use dedicated physical connections to the unit, they are software control lines and as such should not be used for safety interlocks etc.

Speed of Operation

Speed of Operation can be important when defining systems for test applications, therefore it can be beneficial to understand all the necessary overhead delays associated with a switch operation.

If we consider a single relay / block relay operation, it can be considered to be a combination of five discrete operations: PC Processing, Ethernet Latency, LXI Processing / Virtualisation, Serial Loop Transmission and Relay Settling.

A representation of these processes can be seen in the diagram below.

For more information on the [Pickering Sequence Manager](#) please refer to our website.

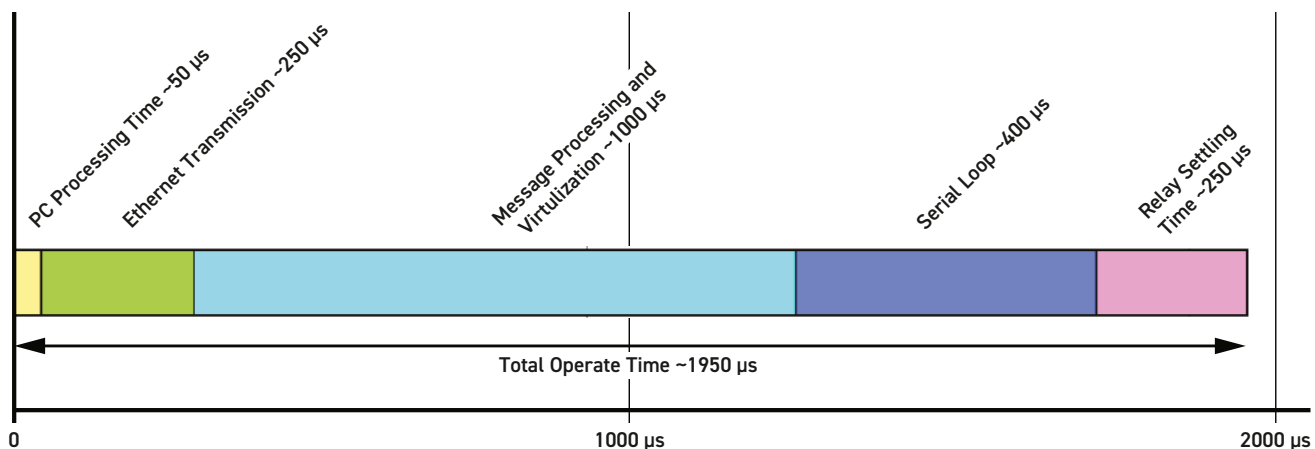

Speed of Operation Diagram For The 65-233

Note: These are estimated figures, PC processing and Ethernet transmission times may vary depending upon the overall system setup and load.

Relay Type

The 65-233 is fitted with high quality tungsten reed relays specifically designed for very high voltage switching and are manufactured by our Relay Division: pickeringrelay.com

High Voltage Switching Specification

Switch Type:	Tungsten Reed
Max Hot Switch Voltage:	7.5 kVDC/7.5 kVAC peak*
Max Cold Switch Voltage:	9 kVDC/9 kVAC peak*
Max Power:	50 W
Max Hot Switch Current:	0.25 A
Max Cold Switch Current:	0.25 A
Initial On Path Resistance:	TBD
Off Path Resistance:	>1x10 ¹² Ω
Operate Time:	3 ms typical
Expected Life:	>1x10 ⁷ operations

* For full voltage rating, signal sources to be switched must be fully isolated from mains supply and safety earth.

RF Specification

Bandwidth (-3dB):	TBD
Crosstalk (typical):	10 kHz: TBD
	100 kHz: TBD
	1 MHz: TBD
	10 MHz: TBD
Isolation (typical):	10 kHz: TBD
	100 kHz: TBD
	1 MHz: TBD
	10 MHz: TBD

Operating/Storage Conditions

Operating Temperature:	0 °C to +55 °C
Humidity:	Up to 90 % non-condensing
Altitude:	5000 m
Storage Temperature:	-20 °C to +75 °C
Humidity:	Up to 90 % non-condensing
Altitude:	15000 m

Safety & CE Compliance

All products are fully CE compliant and meet applicable EU directives: Low-voltage safety EN61010-1:2010, EMC Immunity EN61326-1:2013, Emissions EN55011:2009+A1:2010.

Mechanical Specification

Chassis Dimensions:	2U rack mountable full width, depth 500mm
Number of Plug-ins Supported:	6 (in 65-200-002 chassis)
Plug-in Connectors:	Redel S series (51-pin) high voltage connector
Interlock Connector:	4-pin female 00 series connector (mating halvesupplied with module, to be wired by end user).
Trigger Connector:	25-pin male micro D-type
Chassis Cooling:	Front air intakes through plug-in module holes, temperature controlled speed adjustable fans

Power Source

Universal AC mains supply,	90-120/200-240 V 50-60 Hz.
Power Inlet:	Male IEC connector
Power Rating:	100 VA maximum
Fuse Rating:	(F) 5 A 250 V

LAN Interface

1000Base-T Ethernet Interface with a standard RJ-45 connector mounted on the rear panel. Compliant to LXI Standard 1.5

Triggering

- 16x Software Configurable Bidirectional Open Collector Triggers
- 1x Dedicated Software Reset Line
- 1x Dedicated Software Fault Line

Scan List Sequencing

Capable of storing 5000 predefined test sequences, loaded from the host Controller to the LXI unit at process initialization, with the ability to be triggered through software or from any of the sixteen software configurable triggers.

For more information on the [Pickering Sequence Manager](#) please refer to our website.

Product Order Codes

Specify which modules are required to build the switch. Plug-in modules can be ordered for chassis already supplied.

Chassis	
2U Modular Switching Chassis, 6-Slot	65-200-002
High Voltage Switch Plug-in Module	
50xSPST, 2x 51-pin Redel Connectors	65-233-900-HI
40xSPST, 2x 51-pin Redel Connectors	65-233-901-HI
30xSPST, 2x 51-pin Redel Connectors	65-233-902-HI
20xSPST, 51-pin Redel Connector	65-233-903-HI
10xSPST, 51-pin Redel Connector	65-233-904-HI

Product Customization

Pickering products are designed and manufactured on our own flexible manufacturing lines, giving complete product control and enabling simple customization to meet very specific requirements.

Customization can include:

- Alternative reed relay types
- Mixture of reed relay types
- Alternative number of relays
- Different performance specifications

All customized products are given a unique part number, fully documented and may be ordered at any time in the future.

Please contact your local sales office to discuss.

Connection Accessories

For a complete list of connection accessories and documentation for the 65-233 range please refer to our [51-pin Redel S series connectors datasheet \(90-026HVD\)](#).

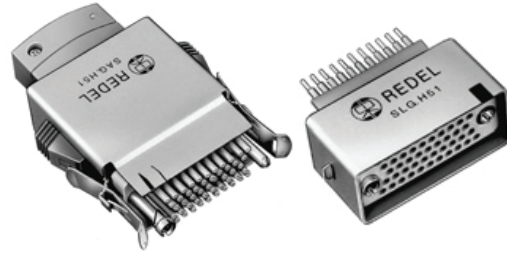

The 65-233 user connections are via front panel mounted high density 51-pin REDEL connectors. These are specifically designed for high voltage working and are tested to 12kV.

Accessories - Interlock Connectors

Plug-in modules are supplied with a mating connector for the hardware interlock function, spare/replacement connectors can be ordered as follows:

Connector with internal link	44-961-040
Connector only, no internal wiring (replacing that supplied with the module)	44-960-040



The 65-233 is part of a growing family of Scalable Switching systems available from Pickering Interfaces. Illustrated is the LXI 65-219 Modular 2 Amp Matrix, available in sizes up to 60x40.



Available from Pickering are the 60-102C and 60-103B LXI Modular Chassis. These are 7 and 18 slot chassis capable of hosting any of our range of PXI switching and programmable resistor modules under LXI control via a Gigabit Ethernet interface. Also available are the 60-104, 60-105 and 60-106. These are 2, 4 & 6 slot LXI/USB Modular Chassis which allow control of our PXI modules via Ethernet or USB.

Overview of “Hot” & “Cold” Switching Techniques

“Hot” Switching

This is when the load is switched with the high voltage source applied. Hot switching may generate considerable RFI, both within the switching module and on interconnecting wiring. Care must be taken to suppress or shield all cabling.

Note that any precaution which adds extra capacitance to a cable should be taken with great care, even a very small capacitance at high voltages can cause very large inrush current through the module resulting in possible switch weld and excessive RFI.

The 65-233 plugins include extensive built-in RFI suppression circuits that minimize RFI and surge problems.

“Cold” Switching – The Preferred Option for Reliability & Long Life.

With cold switching, the relay is operated before the high voltage source is applied. In this case the maximum carry current is much greater, also there will be much less stress on the reed relays, resulting in improved reliability and life.

Most high voltage sources include a soft start facility which reduces the likelihood of generating RFI or temporary over-voltage.

High voltage switching modules are often used for isolation testing applications (e.g. cable, transformer or semiconductor isolation tests), in these cases, cold switching is nearly always the preferred option to reduce the risk of high voltage transients that may cause premature breakdown.

PRELIMINARY DATA

Switch Path Manager Signal Routing Software

Our signal routing software, Switch Path Manager (SPM), simplifies signal routing through switching systems and speeds up the development of switching system software. Switch Path Manager supports our switching modules and the interconnection between them. Once a switching system model has been created, signal routing can be performed by simply defining the endpoints that are required to be connected together. The ability to automate signal routing results in simple and effective switching system management, safe and fast. The short circuit detection feature avoids unwanted shorts between routes.

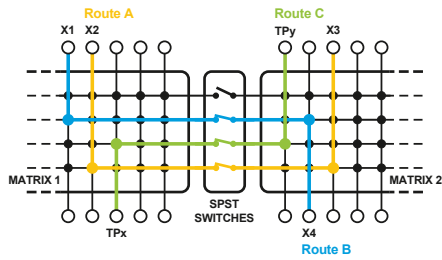

Switch Path Manager Signal Routing Example

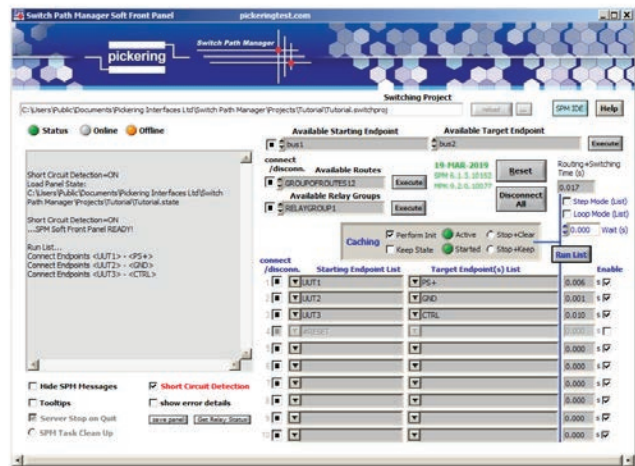

SPM Features:

- Manages Complex Switching Systems
- Reduces Switching Software Development Effort
- Debug Monitor and Manual Control Capability
- Supports all Pickering PXI, LXI and PCI Switching
- APIs available for C, C++, .NET, LabWindows™/CVI and LabVIEW
- Windows 32-bit or 64-bit Compatible
- Free Evaluation License
- Provides Switching Safety Features, including Short Circuit Detection and Endpoint Protection - see below:

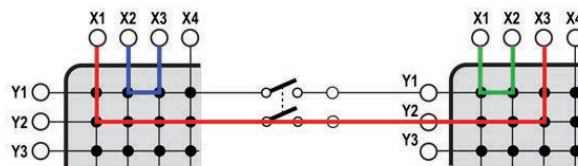

Short Circuit Detection - avoids shorting the blue path with the green path when trying to apply the red path via the 2-pole relay.

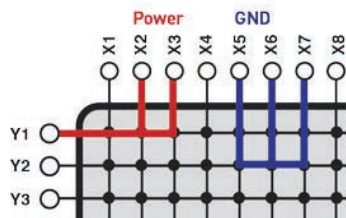

Endpoint Protection - prevents accidental connection of critical nodes such as Power or Ground (Y1, X2, X3) and (X5, X6, X7) are attributed to different Protection Groups in SPM. The software will not allow pins in different groups to be connected together.

Switch Path Manager is available in a full version and a lower-cost lite version. For more information please visit our [Switch Path Manager](http://pickeringtest.com) web page.

Connectivity Solutions

We provide a full range of supporting cable and connector solutions for all our switching products—20 connector families with 1200+ products. We offer everything from simple mating connectors to complex cables assemblies and terminal blocks. All assemblies are manufactured by Pickering and are guaranteed to mechanically and electrically mate to our modules. These accessories are detailed in Connector Accessories data sheets, where a complete list and documentation can be found for each accessory.

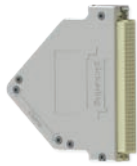

Connectors & Backshells



Multi-way Cable Assemblies

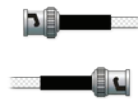

RF Cable Assemblies



Breakouts



Connector Blocks

We also offer customized cabling and have a free online **Cable Design Tool** that can be used to create custom cable solutions for many applications.

- Fully supported on modern browsers and tablet operating systems.
- Built-in tutorials and videos allow you to get quickly up to speed.
- Store cable assemblies in the Cloud and develop over time.
- Each cable design has a downloadable PDF documentation file detailing all specifications

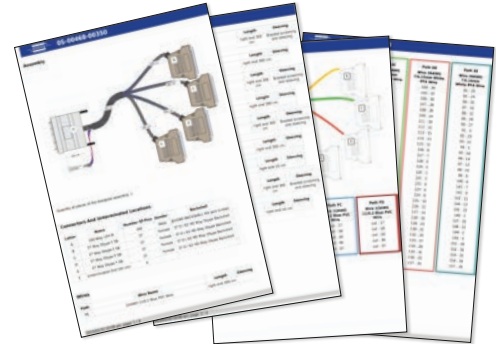

Start designing your custom cabling, go to pickeringtest.com/cdt

Mass Interconnect

We recommend the use of a mass interconnect solution when an Interchangeable Test Adapter (ITA) is required for PXI/LXI based test systems. Our modules are fully supported by Virginia Panel and MacPanel.

Pickering Reed Relays

We are the only switch provider with in-house reed relay manufacturing capability via our Relay Division. These instrument grade reed relays feature **SoftCenter™** technology, ensuring long service life and repeatable contact performance.

To learn more go to pickeringrelay.com

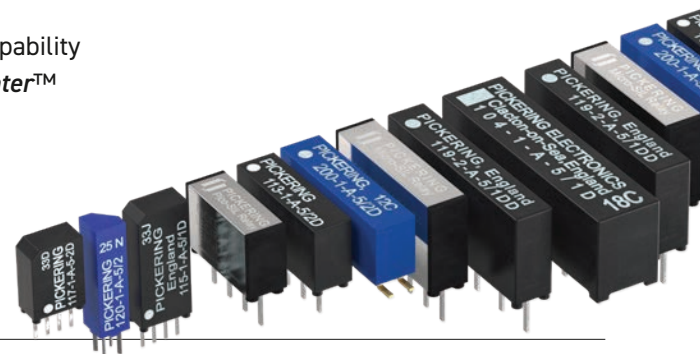

PRELIMINARY DATA

Programming

Pickering provide kernel, IVI and VISA (NI & Keysight) drivers which are compatible with all Microsoft supported versions of Windows and popular older versions.

For more information go to pickeringtest.com/os

The VISA driver support is provided for LabVIEW Real Time Operating Systems (Pharlap and Linux-RT). For other RTOS support contact Pickering. These drivers may be used with a variety of programming environments and applications including:

- Pickering Interfaces Switch Path Manager
- National Instruments products (LabVIEW, LabWindows/CVI, Switch Executive, MAX, TestStand, VeriStand, etc.)
- Microsoft Visual Studio products (Visual Basic, Visual C++)
- Programming Languages C, C++, C#, Python
- Keysight VEE and OpenTAP
- Mathworks MATLAB, Simulink
- Marvin ATEasy
- MTQ Testsolutions Tecap Test & Measurement Suite

Drivers for popular Linux distributions are available, other environments are also supported, please contact Pickering with specific enquiries. We provide Soft Front Panels (SFPs) for our products for familiarity and manual control, as well as comprehensive documentation and example programs to help you develop test routines with ease.

To learn more about software drivers and development environments go to pickeringtest.com/software

Signal Routing Software

Our signal routing software, Switch Path Manager, automatically selects and energizes switch paths through Pickering switching systems. Signal routing is performed by simply defining test system endpoints to be connected together, greatly accelerating Test System software development.

To learn more go to pickeringtest.com/spm

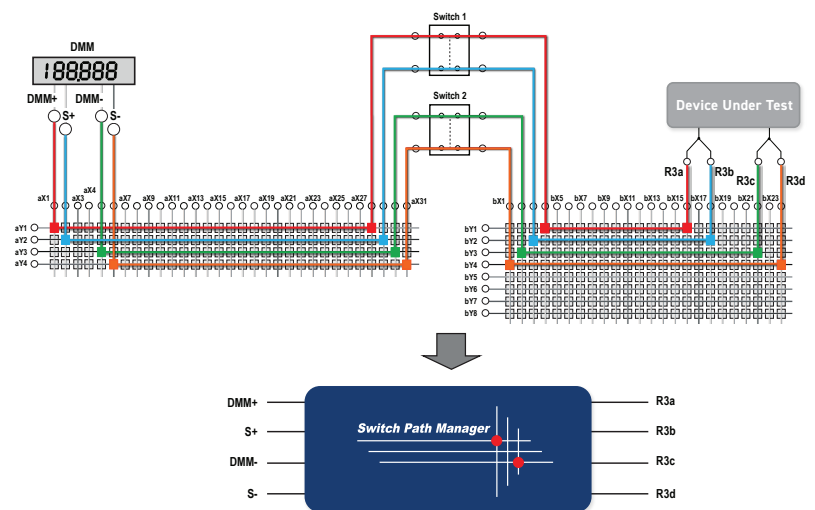

PRELIMINARY DATA

Diagnostic Relay Test Tools

eBIRST Switching System Test Tools are designed specifically for our PXI, PCI or LXI products, these tools simplify switching system fault-finding by quickly testing the system and graphically identifying the faulty relay.

To learn more go to pickeringtest.com/ebirst



Three Year Warranty & Guaranteed Long-Term Support

All standard products manufactured by Pickering Interfaces are warranted against defective materials and workmanship for three years from the date of delivery to the original purchaser. Extended warranty and service agreements are available with various levels for your requirements. Although we offer a 3-year warranty as standard, we also include guaranteed long-term support—with a history of supporting our products for typically 15-20 years.

To learn more go to pickeringtest.com/support

Available Product Resources

We have a library of resources including success stories, product and support videos, articles and white papers as well as application-specific brochures to assist you. We have also published reference books on switching technology and the PXI and LXI standards.

To view, download or request any of our product resources go to pickeringtest.com/resources

